

# GENAP INSTALLATION INSTRUCTIONS / PICTURE GUIDE

## Mechanical Wall Outlets 2"- 3"- 4" for Water Tanks

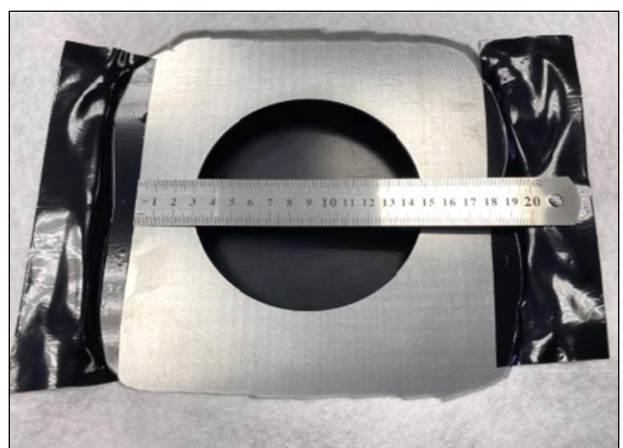

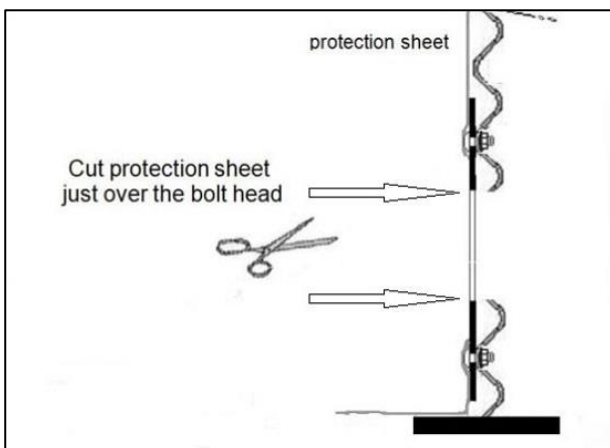
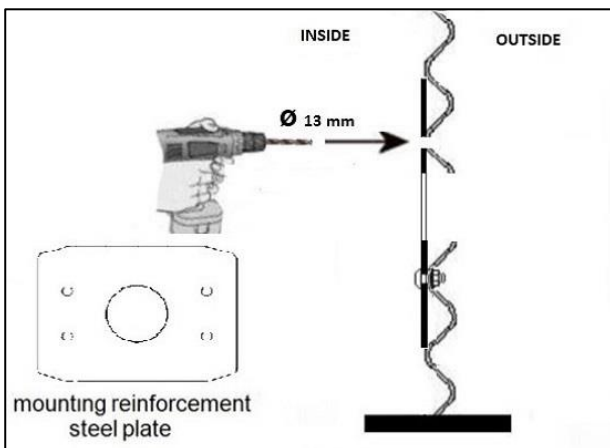
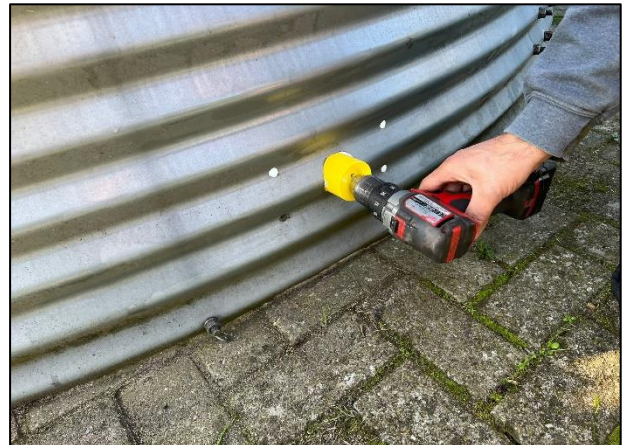
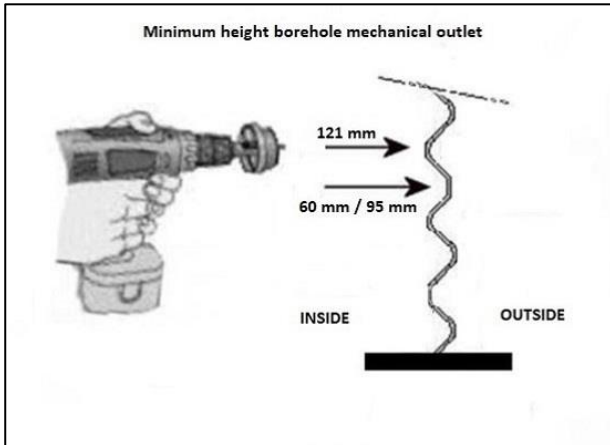
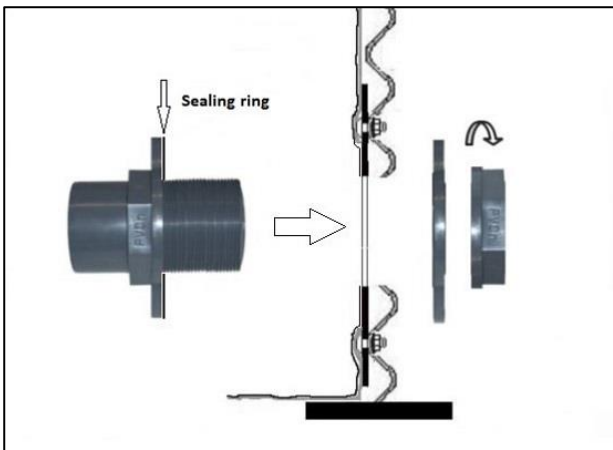
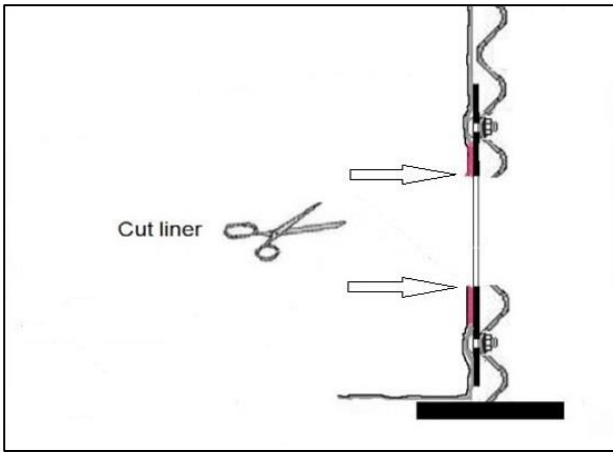

**Minimum Hole Sizes for Tank Fittings**

Fitting	Hole Size
50 mm / 2"	60 mm / 2 <sup>3</sup> / <sub>8</sub> "
75 mm / 3"	95 mm / 3 <sup>3</sup> / <sub>4</sub> "
100 mm / 4"	121 mm / 4 <sup>3</sup> / <sub>4</sub> "